

Parts & Prices for Prospec Lockers & Locks

Marathon Lockers & Cubicles Parts & Prices Maintenance 01.01.12



prospec 
...working around your leisure

Prospec Limited
Maintenance Department
Canklow Meadows Estate, West Bawtry Road, Rotherham S60 2XL, England
Tel: +44 (0)1709 377147 Fax: +44 (0)1709 375239
www.prospec.co.uk Email: mailbox@prospec.co.uk

Contents

Prospec Lock	02	Coin Operated Locks (Build Plan) Stage 4	15
Maintenance Spares Price List	03	Coin Operated Locks (Build Plan) Stage 5	16
Attachments For Prospec Locks	04	Coin Operated Locks (Build Plan) Stage 6	17
Ojmar Coin Operated Lock	05	KABA 20 Fixed Cylinder	18
Lockers Parts & Prices	06	KABA 20 Removable Cylinder	19
Marathon Lockers Components	07, 08, 09	KABA 20 Removable Cyrille	20
Attachments for Lockers	10, 11	Terms & Conditions	21
Coin Operated Locks (Build Plan) Stage 1	12		
Coin Operated Locks (Build Plan) Stage 2	13		
Coin Operated Locks (Build Plan) Stage 3	14		



Marathon Lockers & Cubicles Parts & Prices 01.12.11

Parts & Prices Prospec locks

Prospec Lockers with KABA Coin Operated Locks



www.prospec.co.uk 

All correspondence should be addressed to:
The Maintenance Manger

Marathon Lockers Parts & Prices - PR 01.01.12

Propsec Lockers with Ojmar Coin operated Locks
Maintenance Spares Price List

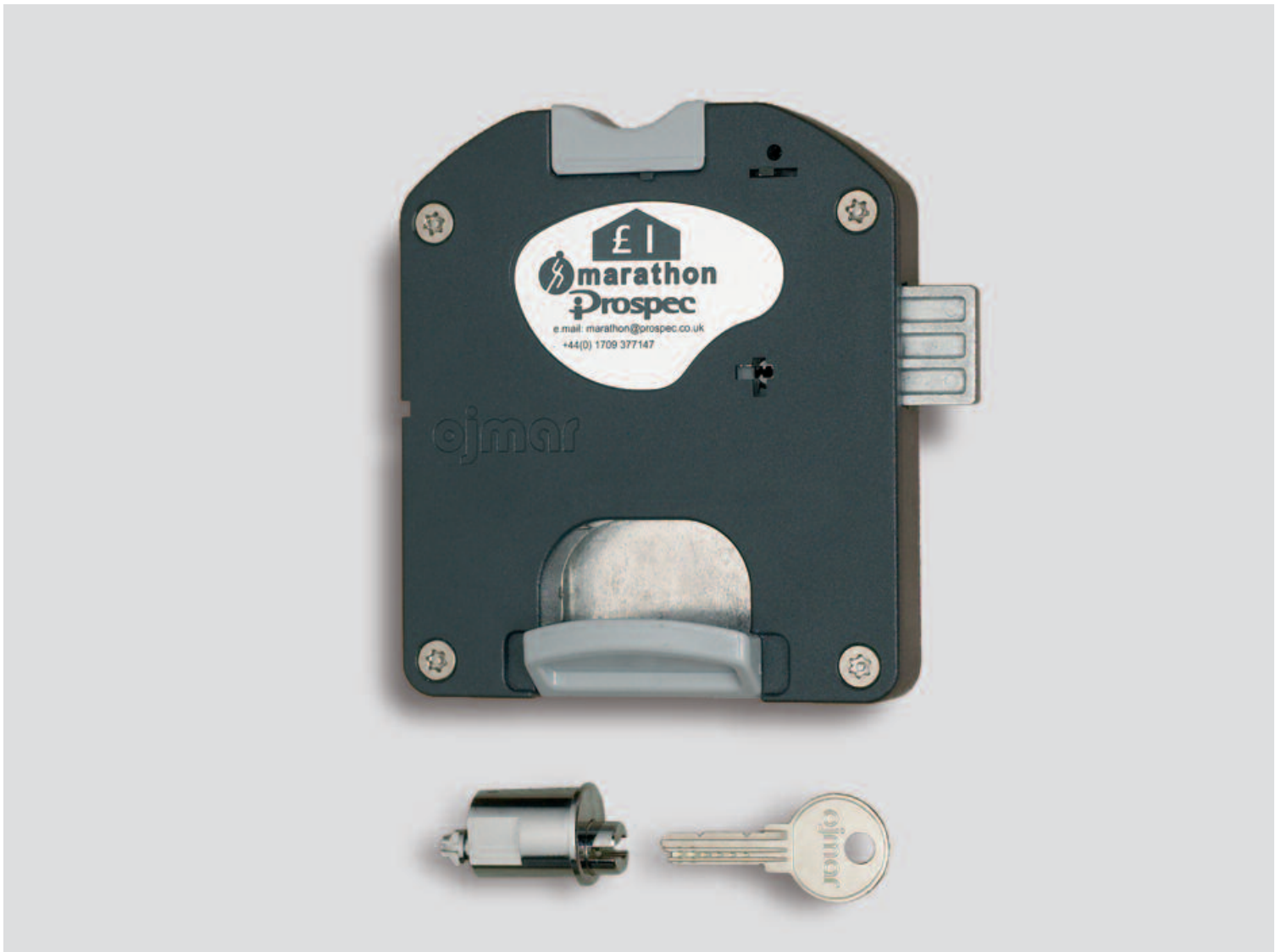

Attachments for Prospec Locks

Ojmar Coin Operated Locks with removable cylinders

Complete Lock with Ojmar removable cylinder	23.00
lock Mechanism (without cylinder and key)	13.75
Ojmar Removable cylinder and key	12.50
AMC11/2 Numberplate	5.50
General Masterkey	5.50
Core Removal Masterkey	5.50
Individual user key	3.00

Ojmar Coin Operated Locks with removable cylinders

A: Lock Housing	5.75
B: Lock Oil	5.95
c: Cylinder Housing with brass washer and screws	6.85
Brass washer and screws only	2.00
D: Lock Cam	3.50
E: Coin Tray	2.65

Accessories for Ojmar Coin Operated locks

BA49 Metal Door Backplate	3.65
AMC9 Barrelnut + STF29 Screw	0.78
AMC11/2 Numberplate for fixed cylinder type lock	5.50
STF29 Screw for barrelnut	0.16
L TS Security Torx Screw	0.46

Coin Operated Locks (Build Plan)
Ojmar Coin Operated Lock

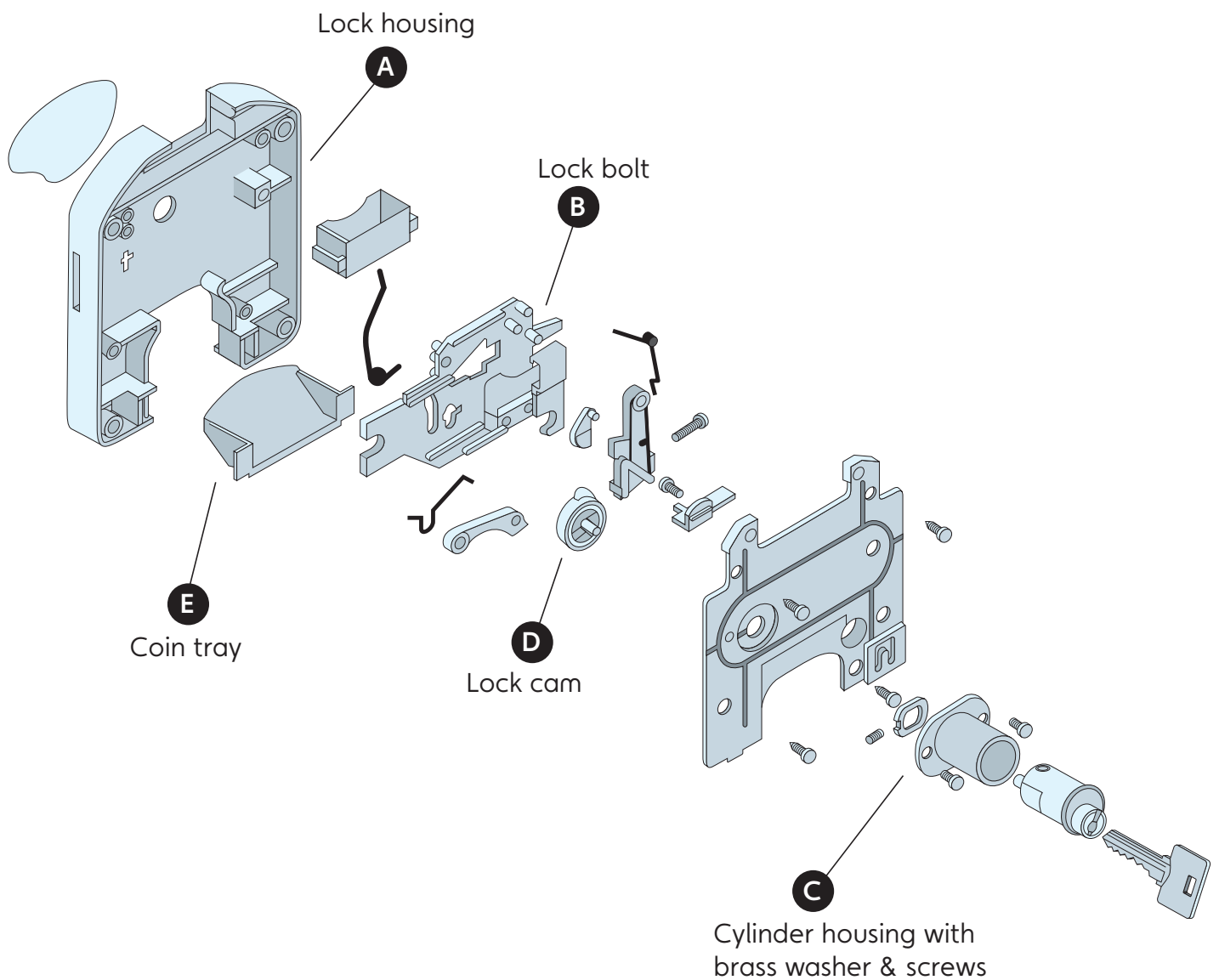

Parts & Prices Prospec lockers

Please refer to drawings

AMC1 Aluminium End Profile (Right Hand Side)	35.00	STF15 12 x3" Slotted panhead self tapping screw	0.25
AMC2 Aluminium End Profile (Left Hand Side)	35.00	STF16 Plastic rawl plug to suit STF14 and STF15	0.08
AMC3 Aluminium Centre Profile	35.00	STF28 M6 x12mm Countersunk Socket Head Screw	0.15
Double Sprung Locker Hinge 3 part	3.50	STF29 M6 x16mm Countersunk Socket Head Screw	0.15
AMC5 Door Stop	2.50	STF30 M6 x 20mm Countersunk Socket Head Screw	0.15
AMC6 Coathook	3.75	MAR39 50mm x 4mm Pop Rivet	0.25
AMC8C Aluminium Rosette	2.65	L TS M5 x 20mm Countersunk Torxscrew (security head)	0.46
AMC9 Barrelnut	0.78	Plastic Locker Shelf (300mm wide)	9.00
STF1 M6 Nut	0.12	Plastic Locker Top (300mm wide)	9.00
STF2 Cerated Washer	0.12	Plastic Locker Base (300mm wide)	9.95
STF3 M6 Nylon Washer	0.11	Plastic Locker Shelf (400mm wide)	10.25
STF4 M6 x 12mm Socket Head Screw	0.15	Plastic Locker Top (400mm wide)	10.55
STF5 M6 x 16mm Socket head Screw	0.18	Plastic Locker Base (400mm wide)	11.25
STF6 M6 x 20mm Socket head Screw	0.18		
STF7 10 x 3,18 Pozi Pan head self tapping screw	0.13		
STF14 12 x 2" Slotted panhead self tapping screw	0.24		

Propsec Marathon Lockers Components

AMC1 | Right hand profile

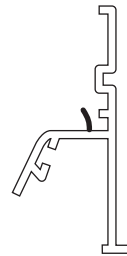

Right hand end of
each locker block

AMC2 | Left hand profile

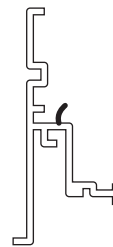

Left hand end of
each locker block

AMC3 | Centre profile

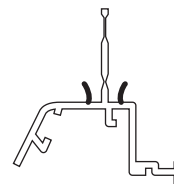

Division between each
individual locker

AMC4A | 3 part hinge

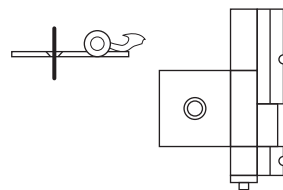

Standard: Use 3 part
sprung hinge

One of each type to be
used on 5+6 tier lockers

AMC5 | Door stop



Right Hand End of
Each Locker Block



Propsec Marathon Lockers Components

AMC6 | Coat Hook

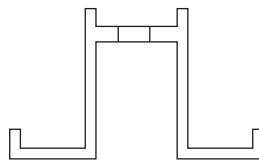

Used in 1+2 tier locker compartments

AMC8C | Long rosette

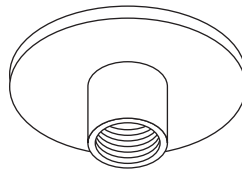

10/12/13mm thick locker door outer hinge fixing + 4 per end panel fixing



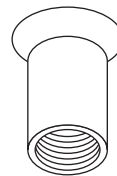

















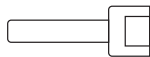



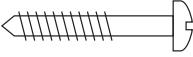

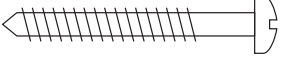

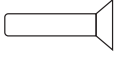

AMC9 | Barrel nut



Exterior number plate fixing

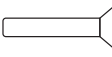

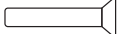
Propsec Marathon Lockers Components

STF 1	M6 nut (1/4 approx)			To go with STF 6 & STF 30
STF 2	M6 serrated washer (1/4" approx)			To go with STF 4 hanger
STF 3	M6 nylon washer (1/4" approx)			To go with STF 5
STF 4	M6 x 12mm socket head screw (1/4" x 1/2" approx)			AMC 6 coat hook
STF 5	M6 x 16mm socket head screw (1/4" x 5/8" approx)			End & closure panels
STF 6	M6 x 20mm socket head screw (1/4" x 3/4" approx)			Body, top, shelf, base & AMC 3
STF 7	No 10 x 3/8" Pozi pan s/tap (4.5mm x 10mm approx)			Top, base & shelf
STF 14	No 12 x 2" slotted plan s/tap (5mm x 50mm approx)			Locker to wall
STF 15	No 12 x 3" slotted plan s/tap (5mm x 75mm approx)			Locker to plinth
STF 16	Plastic plug to suit STF 14 & STF 15			
STF 28	M6 x 12mm C/SK socket (1/4" x 1/2" approx)			Hinge to door with AMC 8/A
STF 30	M6 x 20mm socket head screw (1/4" x 3/4" approx)			Body, top, shelf, base, AMC1, AMC2
STF 229	M6 x 16mm socket head screw (1/4" x 5/8" approx)			AMC19 & AMC9 (12mm thick laminated)
STF 11	M5 x 8mm Pozi pan head screw (1/4" x 5/16" approx)			Propsec coin collection
STF 12	M5 x 25mm socket head screw (3/16" x 1" approx)			ASSA coin locks
MAR 39	50mm x 4mm pop rivet			AMC 9 to MAR1 profile
LTS	M5 x 20mm C/SK torx screw (3/16" x 3/4" approx)			Propsec lock to base

Attachments for Prospec Lockers

PKS Prospec Keystrip with metal buckle

Supply only with loose rivets	2.10
Numbered	2.00
Un-numbered	

Rivets (Pair)	0.33
Loops	0.33
Buckle Sets (3 Parts)	0.95
Rivet Tool	22.50

Note: Colours of PKS straps are white, red, blue, yellow, green, orange, black, grey and clear

ISKS All! Plastic Keystrip

Supply only with loose rivets	3.00
Numbered	2.90
Un-numbered	

Rivets (Pair)	0.33
Rivet Tool	22.50

Note: Colours of ISKS straps are white, red, blue, yellow, green, orange, black, brown and grey.

Discs and Pins

Ivory disc 25mm diameter (white with black numbers)	0.90
Ivory disc 25mm diameter (other colour combinations)	0.90
Stainless Steel Split Ring 15mm diameter	0.32
Fishtail Pin	0.75

Maintenance Tools and Equipment for Prospec Coin Operated Locks

Basic hexagonal bent allenkeys

3mm alien key	0.75
4mm allenkey	0.80
5mm allenkey	0.90

T Handed hexagonal allenkeys

3mm angled allenkey	6.75
3mm straight allenkey	5.75
4mm straight allenkey	5.75
5mm straight allenkey	5.90

Torx Screwdriver	19.00
20" Drill Bit	7.95
Rosette Grip Tool	22.50
Rivet Tool	22.50
KABA Spray Lock Lubricant	7.95

Full tool kit for Prospec Coin Operated Locks (note Full tool kit includes T handled type allenkeys and Torx Screwdriver)	64.00
---	-------

Attachments for Prospec Lockers

KABA Coin Operated Locks with removable cylinders 'Refer to drawing LCK-IS07)

Complete Lock with KABA 20 removable cylinder	69.75
Lock Mechanism (without cylinder and key)	35.50
KABA 20 Removable cylinder and key	34.25
AMC10/2 Numberplate	5.50
General Masterkey	13.50
Core Removal Masterkey	13.50
Individual user key	7.25

KABA Coin Operated Locks with fixed (non removable) cylinders (Refer to drawing LCK- IS06)

Complete lock including cylinder and key	56.50
Cylinder and key mounted onto lock backplate	43.50
General Masterkey	13.50
Individual user key	7.25

Accessories for KABA Coin Operated Locks (with removable and fixed cylinder)

ISN16 Plastic Door Backplate	6.25
BA16 Aluminium Door Backplate	8.75
AMC9 Barrelnut + STF29 Screw	0.78
AMC10/2 Numberplate for removable cylinder type lock	5.50
AMC11/2 Numberplate for fixed cylinder type lock	5.50
STF29 Screw for barrel nut	0.15
L TS Security Tone. Screw	0.46

Internal components for KABA Coin Operated locks (Refer to build up plans)

D0001 Housing	5.85
D0002 Penalty return Spring	1.25
D0003 Return Arm	1.25
D0004 Penalty pawl	2.90
D0005 Pivot Arm	2.95
D0006 Coin Shute	1.35
D0007 Coin Gate	1.95
D0008 Bolt	6.25
D0009 Bolt Clamp	1.75
D0010 Return Arm Spring	1.55
D0011 Bolt Return Pawl	1.55
D0012 Bolt Return Spring	1.55
D0013 Pivot Arm Spring	1.55
D0014 Coin Retain Plate	2.75
D0015 Coin Drive Casette	1.50
D0018 Backplate for removable cylinder type lock (plastic)	8.50
D0020 Lock Drive Cam for removable cylinder type lock	3.50
D0022 Screw for 00018100019 Backplate (set of 3)	0.16

Coin Operated Locks (Build Plan)
Stage 1

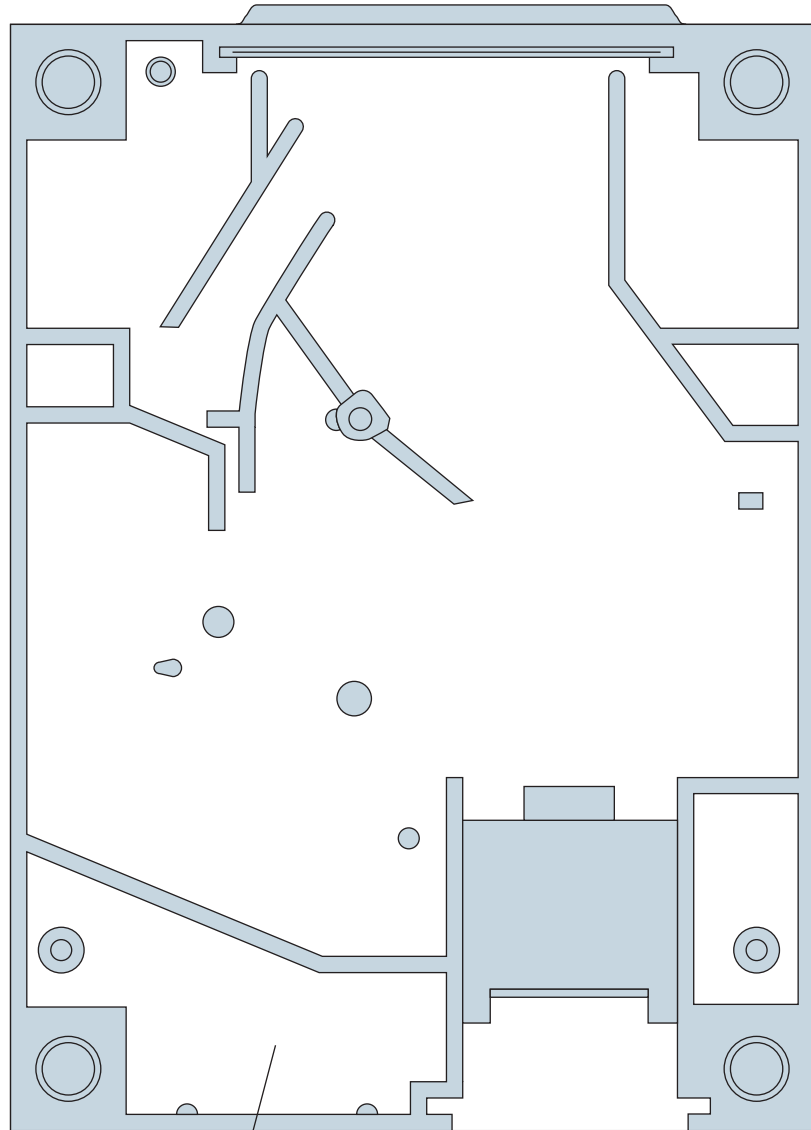

1

Housing
D0001

Coin Operated Locks (Build Plan)
Stage 2

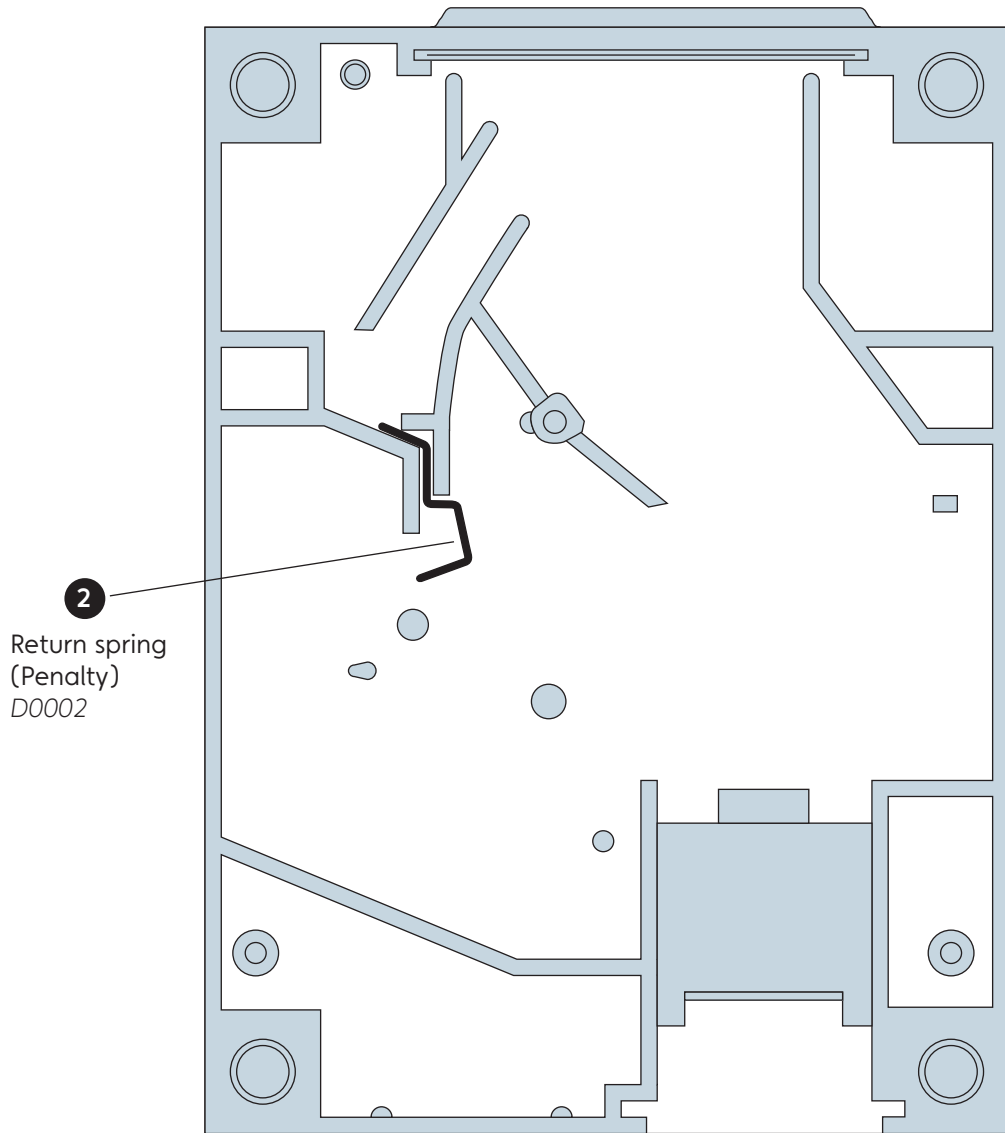

2
Return spring
(Penalty)
D0002

Coin Operated Locks (Build Plan)
Stage 3

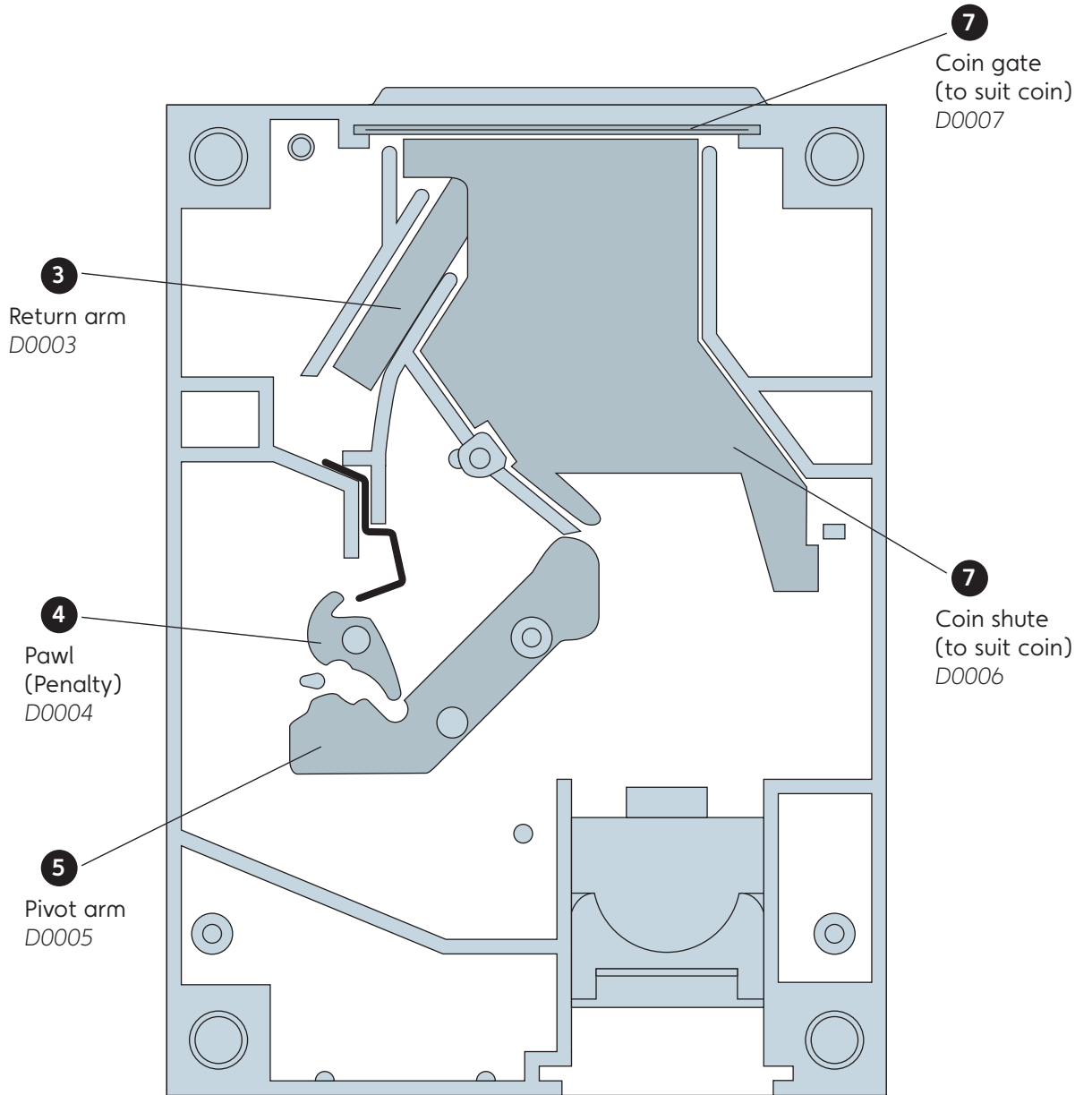

Coin Operated Locks (Build Plan)
Stage 4

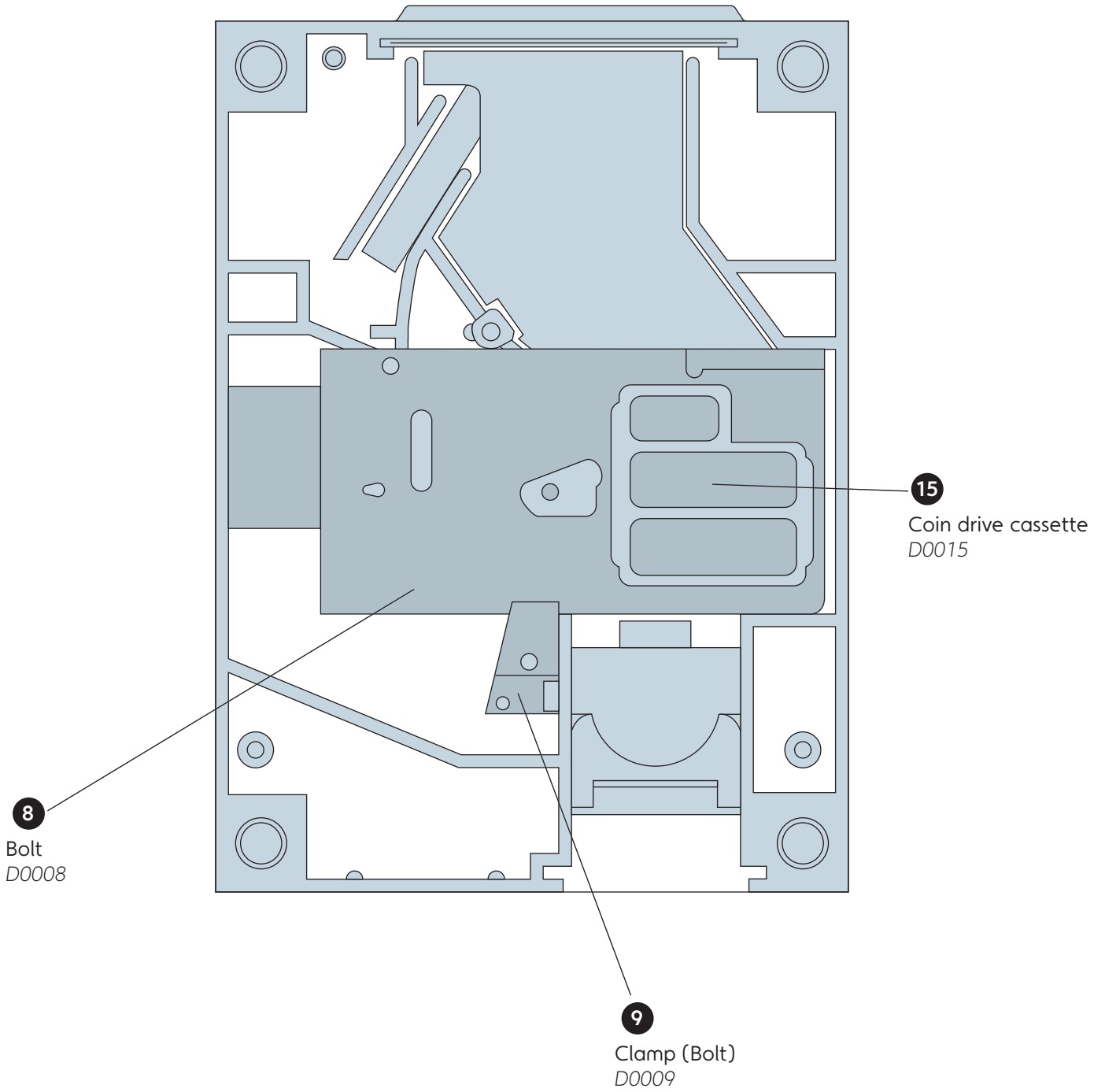

Coin Operated Locks (Build Plan)

Stage 5

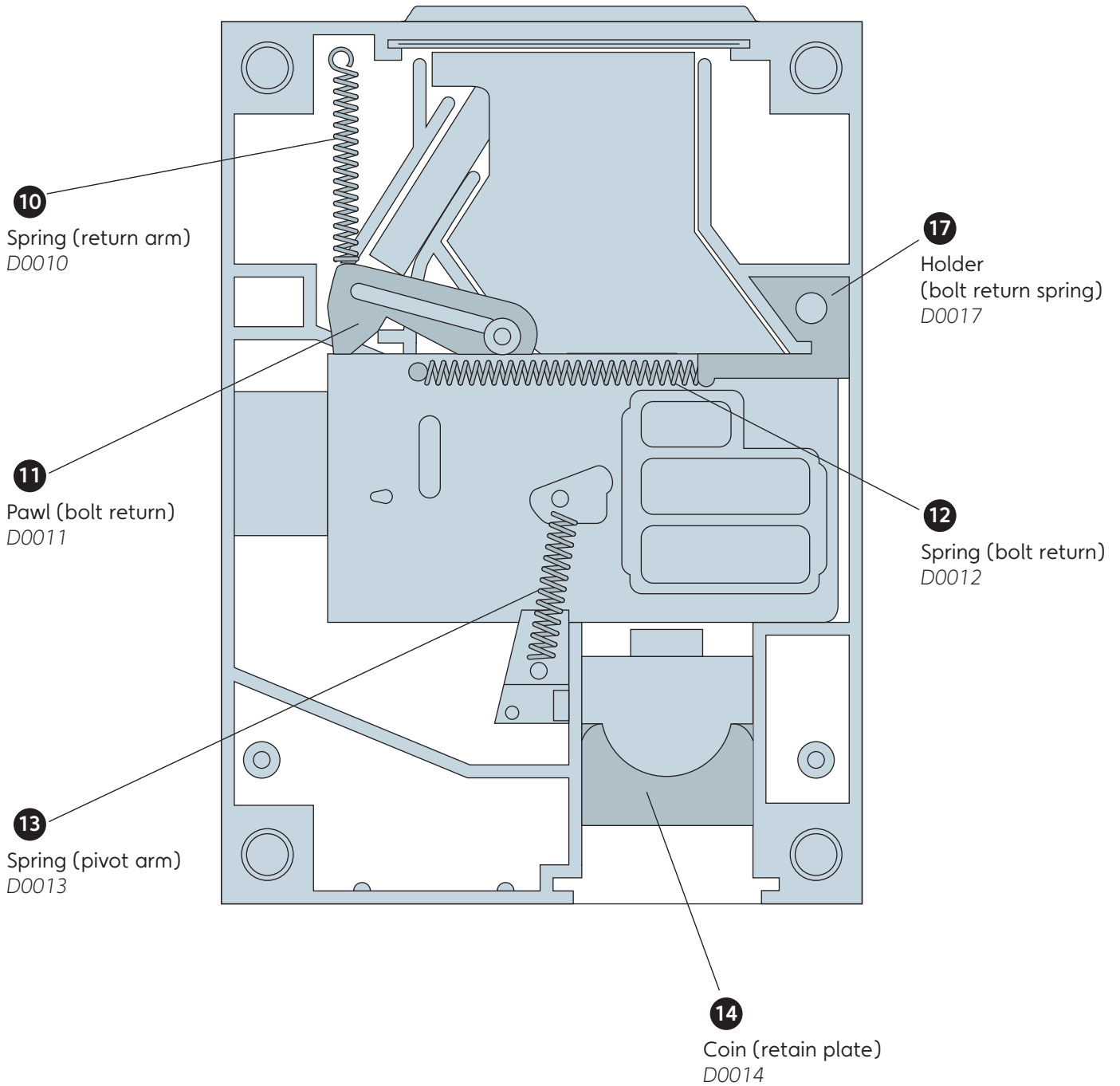

Coin Operated Locks (Build Plan)
Stage 6

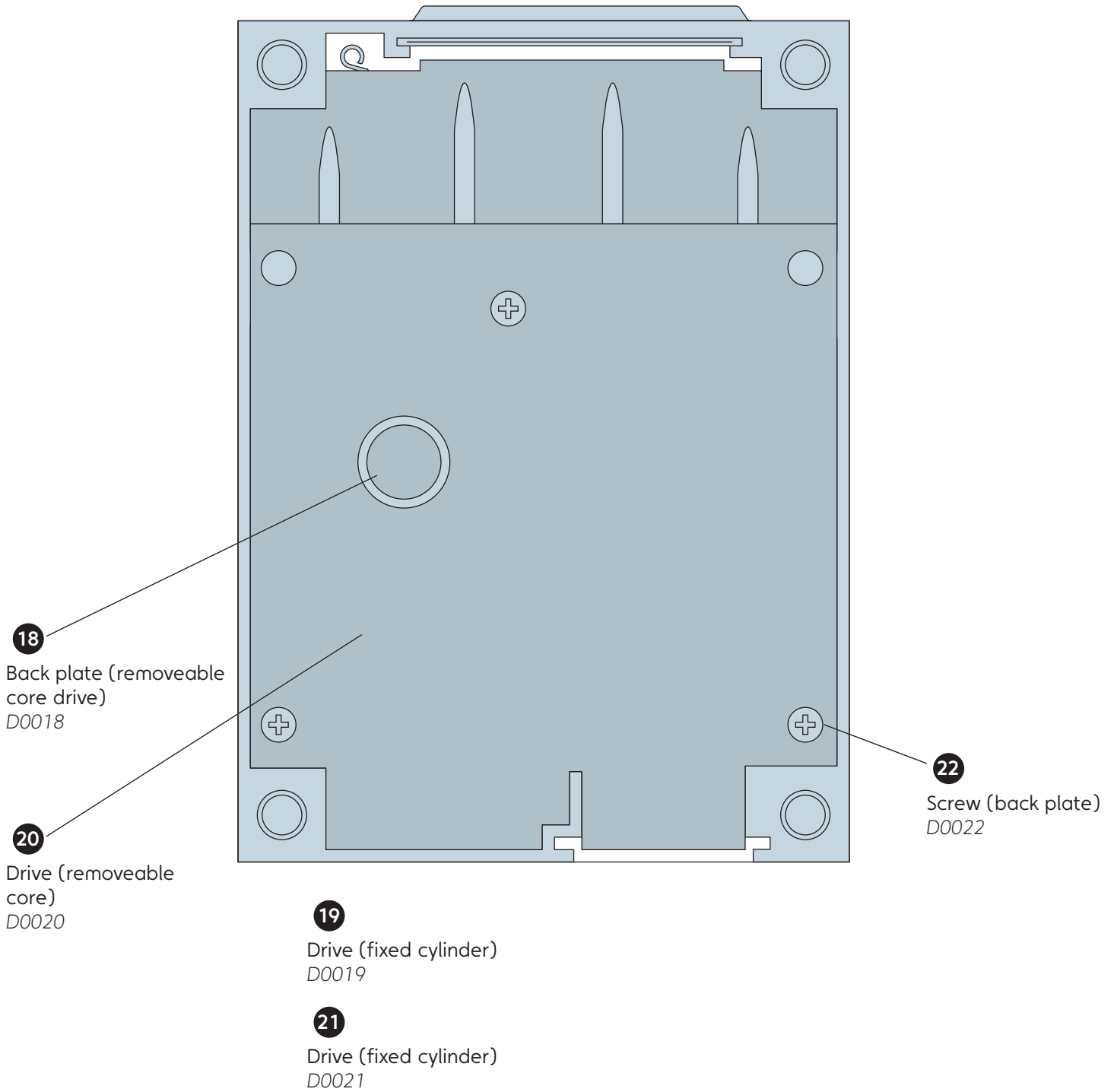

KABA 20 Fixed Cylinder

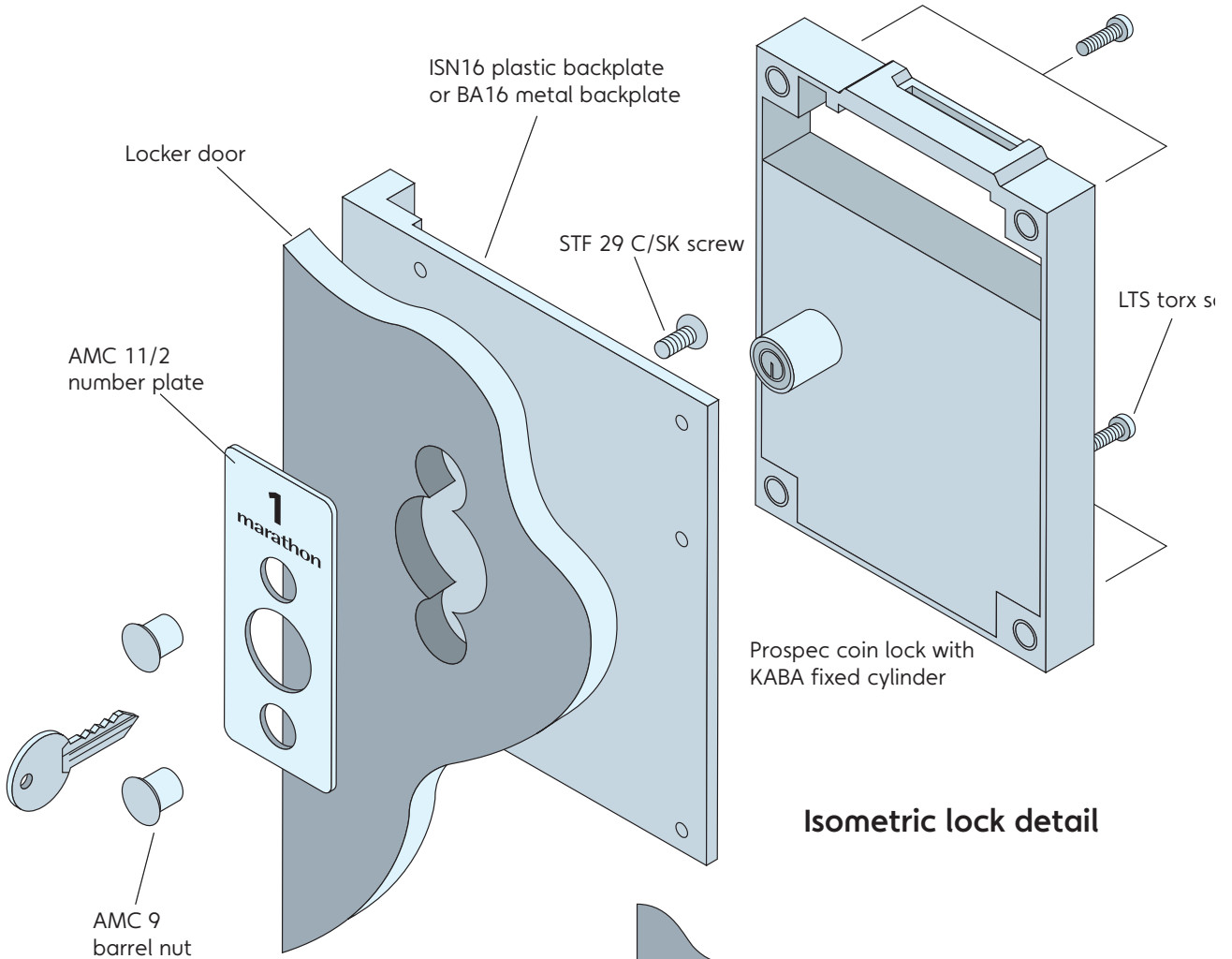

Isometric lock detail

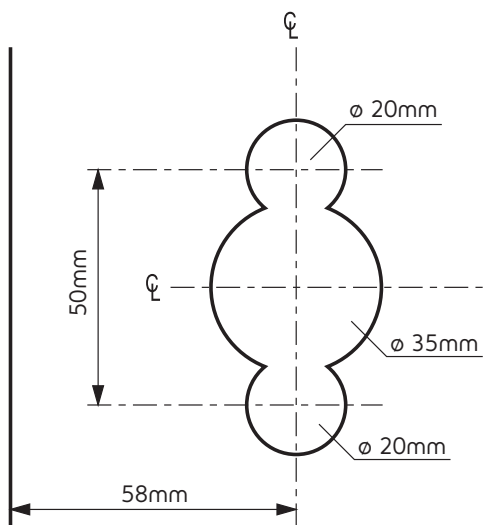

Lock cut out detail

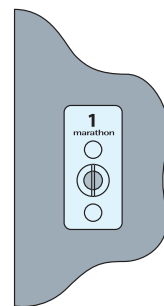

Isometric elevation

Part List

- Prospec Coin Lock x1
- KABA 20 Fixed Cylinder x1
- AMC 11/2 Number Plate x1
- ISN Back Plate x 1
- STF 28 Screw x 2
- AMC Barrel Nut x 2
- LTS Torx Screws x 4
- Lock Keys x 2

KABA 20 Removable Cylinder

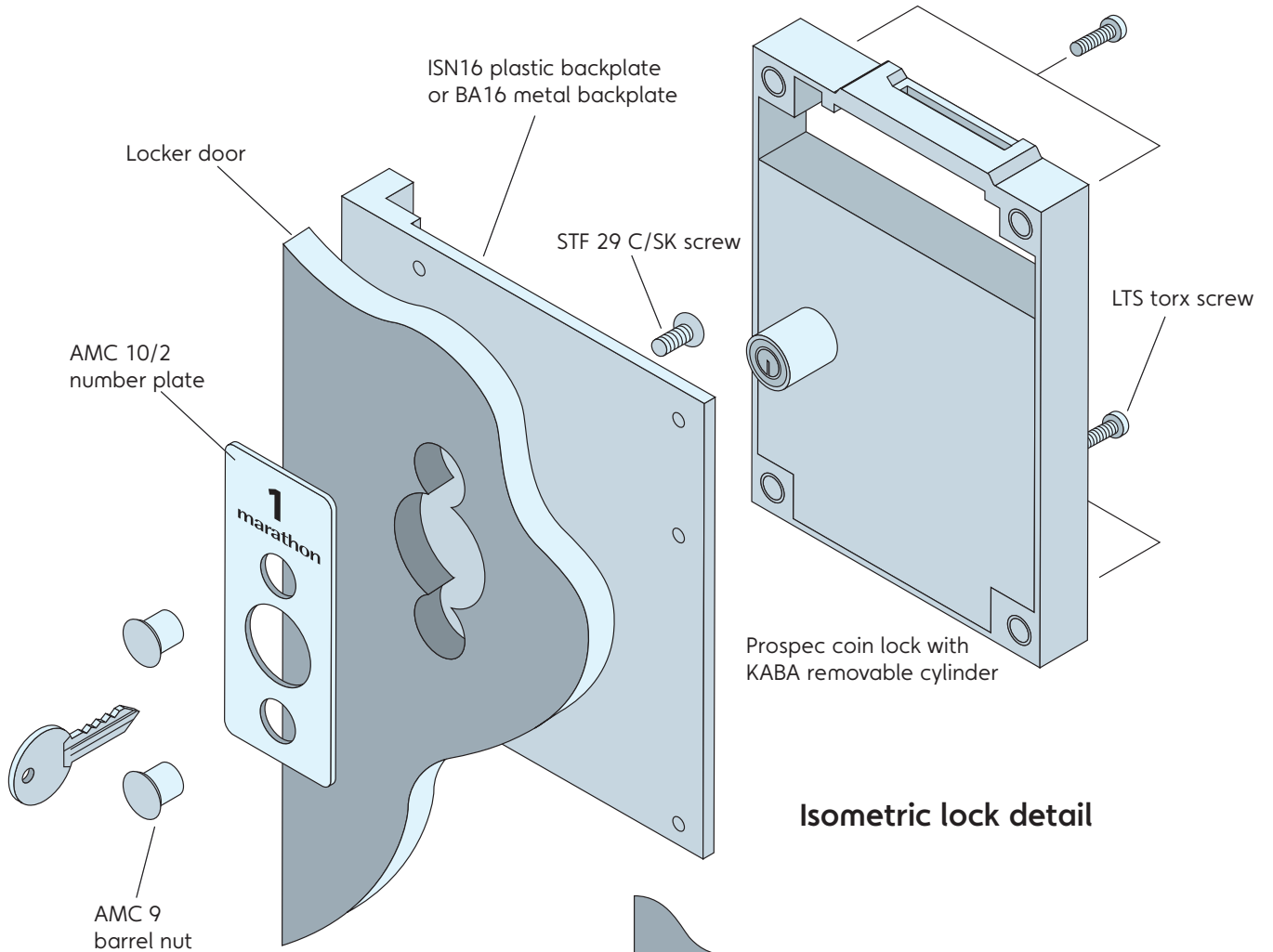

Isometric lock detail

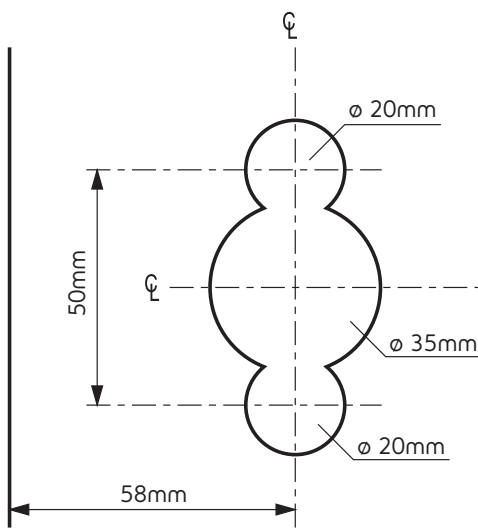

Lock cut out detail

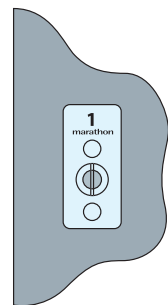

Isometric elevation

Part List
Prospec Coin Lock x1
KABA 20 Fixed Cylinder x1
AMC 11/2 Number Plate x1
ISN Back Plate x 1
STF 28 Screw x 2
AMC Barrel Nut x 2
LTS Torx Screws x 4
Lock Keys x 2

Propsec Marathon Lockers Parts & Prices Terms & Conditions

Minimum order value charges £25.00 nett (Unless payment is made with order).

The price list is correct at the time of issue but may be altered without notification, from time to time. Prices will be invoiced at the prices current on the date of despatch.

Carriage will be charged at additional cost.

Prices do not include vat which will be charged at the current rate.

Unless credit terms have been agreed orders will be processed on a Pro Forma payment basis. Methods of payment include most major credit cards.

Orders are only accepted when subject to the conditions of sale of this company. No other conditions or terms are acceptable.

Claims for non-delivery or shortages must be notified within 7 days of despatch.

Title of ownership of the goods shall not pass to the purchaser until full settlement has been made to this company. Risk of the goods shall pass to the shortager upon delivery.

Prices are supply only and do not include installation.